



车间手推车配备齐全，车头设计精美，质量上乘。

- Tool Rebel 设计中的专用车间手推车
- 由于双面设计，设计极为坚固
- 有 7 个抽屉（5 个平，2 个高），其中 2 个扁平抽屉配备有泡垫和工具
- 扁平抽屉尺寸（宽x高x深）：522 x 81 x 398 mm
- 高抽屉尺寸（宽x高x深）：522 x 166 x 398 mm
- 100% 抽屉用滚珠轴承伸缩滑块抽出，自动关闭
- 所有抽屉均经过精心设计，层搭独一无二
- 由于抽屉止位块，倾斜的风险极小——只能打开一个抽屉，不能同时抽出多个抽屉
- 高品质、耐用的泡沫嵌件，不使用化学气体
- 贴合度优化，可从泡垫中以最佳方式移除工具



9700 Tool Rebel 车间手推车 1



包括以下泡垫

9710



9720

1/4"

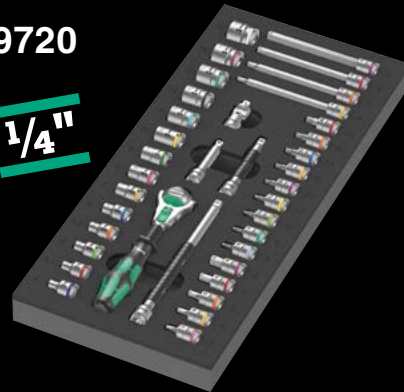

9731



9740



Tool Rebel 设计中的专用车间手推车。五个扁平抽屉和两个高抽屉确保工具和材料的高效移动设计。由于双壁构造和全焊结构，设计极为坚固。适用于车间日常高强度工作。配备四块 Wera 泡垫：9710 泡垫螺丝刀组套 1，9720 泡垫 8000 A Zyklus 棘轮组套 1，9731 泡垫 6003 Joker 环形扳手组套 1，9740 泡垫 L 型扳手组套 1。

05150130001 1x 9700 Tool Rebel 车间手推车 1

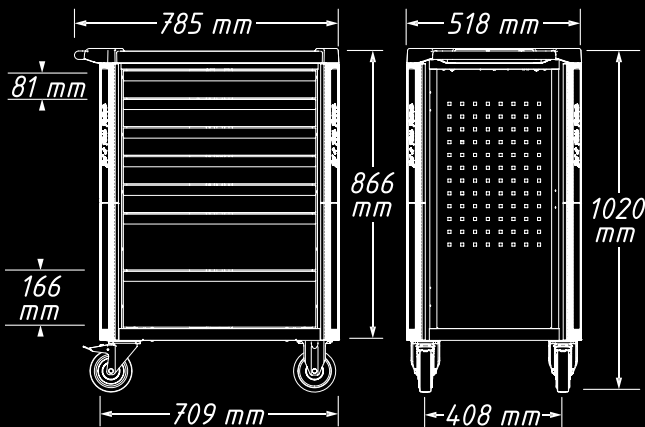

设计坚固以适应车间的高强度工作

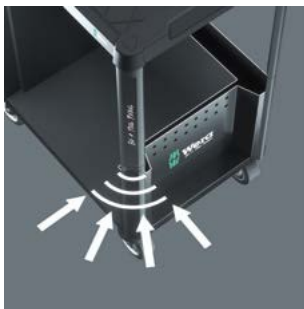

双壁构造和完全焊接的结构使得 "Tool Rebel" 车间手推车极其坚固。在所有四个角落优化的屈服边缘保护,通过内部缓冲作用,确保了可靠的冲击保护。

锁紧牢固, 运行顺畅



两台旋转式方向轮配备双挡块: 锁定的方向轮可靠防止了方向轮滚动, 锁定的主轴托架防止方向轮无意中转动, 例如在倾斜的表面。耐油和耐酸弹性轮确保其顺利运行。防护环防止污垢和螺纹进入。

更安全的详细锁定概念



锁具的人体工学排列的横向位置提高了可用性, 保护了钥匙和锁具免受损坏。极其牢固的锁紧系统可以保护储存在车间手推车中的工具免受未经授权的进入。中央锁定由气缸锁定完成。随附两把可折叠的钥匙。

高负荷



车间手推车动载荷540kg, 静载荷1,000kg, 抽屉动载荷25kg。

9710 泡垫螺丝刀组套 1



18 件工具组套 (16 个螺丝刀, 2 个螺丝夹具) 装入 Tool Rebel 车间手推车的双色泡垫内。宽x高x深: 无工具 344 x 30 x 392 mm, 有工具 344 x 47 x 392 mm。

05150101001		
⊖	932 A	1x 1,0x5,5x100; 1x 1,2x7,0x125
⊕	350	1x PH 1x80; 1x PH 2x100; 1x PH 3x150
⊕	350 PH Stubby	1x PH 2x25
⊕	355	1x PZ 1x80; 1x PZ 2x100
⊖	335	1x 0,8x4,0x100; 1x 1,0x5,5x125
⊖	334	1x 1,2x6,5x150
⊖	335 Stubby	1x 1,0x5,5x24,5
⊕	2050 Micro	1x PH 0x40 ¹⁾
⊖	2035 Micro	1x 0,40x2,5x80
⊖	160 i VDE	1x 0,4x2,5x80 ²⁾ ; 1x 0,6x3,5x100 ²⁾
	1441	1x 4,5-6,0x41,0
	1442	1x 6,0-8,5x41,0
	9810	1x 344,0x30,0x392,0

¹⁾ 尺寸0根据JIS 0 (日本相机工业标准) 修改

²⁾ 不带Lasertip激光蚀刻刀头

9711 泡垫 VDE 螺丝刀组套 1

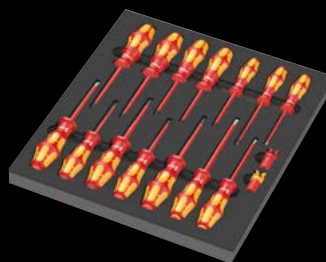

16 件 VDE 绝缘螺丝刀组套 (14 个螺丝刀, 2 个螺丝夹具) 装入 Tool Rebel 车间手推车的双色泡垫内。宽x高x深: 无工具 344 x 30 x 392 mm, 有工具 344 x 46 x 392 mm。

05150102001		
⊕	162 iS PH VDE	1x PH 1x80; 1x PH 2x100
⊕	165 iS PZ VDE	1x PZ 1x80; 1x PZ 2x100
⊕	165 i PZ/S VDE	1x # 2x100
⊖	160 i VDE	1x 0,4x2,5x80 ¹⁾ ; 1x 0,8x4,0x100; 1x 1,0x5,5x125
⊖	160 iS VDE	1x 0,6x3,5x100
⊖	167 i TORX® VDE	1x TX 10x80; 1x TX 15x80; 1x TX 20x80; 1x TX 25x100; 1x TX 30x100
	1440	1x 4,5-6,0x41,0
	1442	1x 6,0-8,5x41,0
	9811	1x 344,0x30,0x392,0

¹⁾ 不带Lasertip激光蚀刻刀头

- 高品质、耐用的泡沫插件，不使用化学气体
- 贴合度优化，可从泡垫中以最佳方式移除工具
- 防水拒油，维护成本低，易于清洁
- 保护工具免受污垢和冲击

9712 泡垫 TORX® HF 螺丝刀组套 1

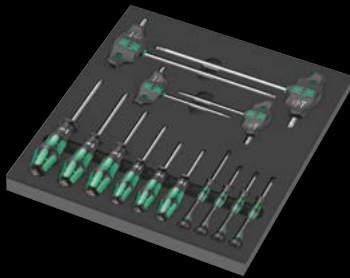

带 TORX® 梅花螺丝固持功能的 14 件螺丝刀组套装入 Tool Rebel 车间手推车的双色泡垫内。宽x高x深 (无工具) : 344 x 30 x 392 mm、有工具 344 x 45 x 392 mm。

05150103001	
⊙	367 TORX® HF 1x TX 8x60; 1x TX 9x60; 1x TX 10x80; 1x TX 15x80; 1x TX 20x100; 1x TX 25x100
⊙	2067 TORX® HF Micro 1x TX 4x40; 1x TX 5x40; 1x TX 6x40; 1x TX 7x60
⊙	467 TORX® HF 1x TX 20x100; 1x TX 25x100; 1x TX 30x200; 1x TX 40x200
9812	1x 344,0x30,0x392,0

9713 泡垫六角螺丝刀组套 1

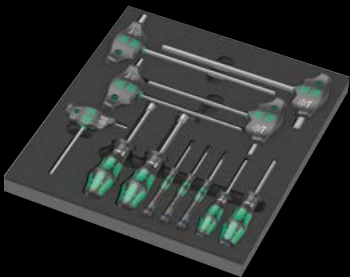

内六角螺丝和外六角螺丝的 12 件螺丝刀组套装入 Tool Rebel 车间手推车的双色泡垫内。宽x高x深 (无工具) : 344 x 30 x 392 mm、有工具 344 x 45 x 392 mm。

05150104001	
⊙	354 1x 3,0x75; 1x 4,0x75
⊙	2054 Micro 1x 1,5x60; 1x 2x60; 1x 2,5x60
⊙	454 HF 1x 4x100; 1x 5x100; 1x 6x150; 1x 8x200; 1x 10x200
⊙	395 H0 1x 10,0x90; 1x 13,0x90
9813	1x 344,0x30,0x392,0

9720 泡垫 8000 A Zyklop 1/4" 棘轮组套 1

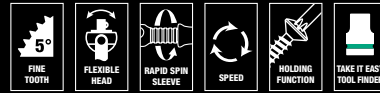

37 件 1/4" Zyklop 棘轮组套装入 Tool Rebel 车间手推车的双色泡垫内。宽x高x深: 无工具 172 x 30 x 392 mm、有工具 172 x 40 x 392 mm。

05150110001	
⊙	8000 A 1x 1/4"x152,0
⊙	8794 LA 1x 1/4"x150,0
⊙	8794 SA 1x 1/4"x75,0
⊙	8795 A 1x 1/4"x35,5
⊙	8794 A 1x 1/4"x56,0
⊙	8790 HMA 1x 4,0x23,0; 1x 4,5x23,0; 1x 5,0x23,0; 1x 5,5x23,0; 1x 6,0x23,0; 1x 7,0x23,0; 1x 8,0x23,0; 1x 9,0x23,0; 1x 10,0x23,0; 1x 11,0x23,0; 1x 12,0x23,0; 1x 13,0x23,0; 1x 14,0x23,0; 1x 15,0x23,0
⊙	8767 A HF 1x TX 8x28,0; 1x TX 9x28,0; 1x TX 10x28,0; 1x TX 15x28,0; 1x TX 20x28,0; 1x TX 25x28,0; 1x TX 27x28,0; 1x TX 30x28,0; 1x TX 40x28,0
⊙	8740 A HF 1x 3,0x28,0; 1x 4,0x28,0; 1x 4,0x100,0; 1x 5,0x28,0; 1x 5,0x100,0; 1x 6,0x28,0; 1x 6,0x100,0; 1x 8,0x28,0; 1x 8,0x100,0
9820	1x 172,0x30,0x392,0

9721 泡垫 8000 B Zyklop 3/8" 棘轮组套 1

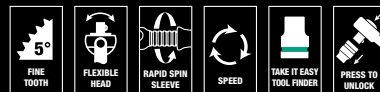

23 件 3/8" Zyklop 棘轮组套装入 Tool Rebel 车间手推车的双色泡垫内。宽x高x深: 无工具 172 x 30 x 392 mm、有工具 172 x 45 x 392 mm。

05150111001	
⊙	8000 B 1x 3/8"x199,0
⊙	8794 SB 1x 3/8"x125,0
⊙	8794 LB 1x 3/8"x200,0
⊙	8795 B 1x 3/8"x50,0
⊙	8794 B 1x 3/8"x76,0
⊙	8790 HMB 1x 6,0x29,0; 1x 7,0x29,0; 1x 8,0x29,0; 1x 9,0x29,0; 1x 10,0x29,0; 1x 11,0x29,0; 1x 12,0x29,0; 1x 13,0x29,0; 1x 14,0x29,0; 1x 15,0x29,0; 1x 16,0x30,0; 1x 17,0x30,0; 1x 18,0x30,0; 1x 19,0x30,0; 1x 20,0x30,0; 1x 21,0x30,0; 1x 22,0x30,0; 1x 24,0x32,0
9821	1x 172,0x30,0x392,0

注意：泡垫不适用于旧型号 05501051001 的车间手推车。

9722 泡垫 8000 C Zyklop 1/2" 棘轮组套 1



31 件 1/2" Zyklop 棘轮组套装入 Tool Rebel 车间手推车的双色泡垫内。宽x高x深: 无工具 344 x 30 x 392 mm、有工具 344 x 51 x 392 mm。

05150112001		
●	8000 C	1x 1/2"x277,0
●●	8794 LC	1x 1/2"x250,0
●●	8794 SC	1x 1/2"x125,0
●●	8795 C	1x 1/2"x69,0
●●	8794 C	1x 1/2"x52,0
●	8790 HMC	1x 10,0x37,0; 1x 11,0x37,0; 1x 12,0x37,0; 1x 13,0x37,0; 1x 14,0x37,0; 1x 15,0x37,0; 1x 16,0x37,0; 1x 17,0x37,0; 1x 18,0x37,0; 1x 19,0x37,0; 1x 20,0x37,0; 1x 21,0x37,0; 1x 22,0x37,0; 1x 24,0x37,0; 1x 27,0x40,0; 1x 30,0x42,0; 1x 32,0x42,0
○	8740 C HF	1x 4,0x60,0; 1x 4,0x140,0; 1x 5,0x60,0; 1x 5,0x140,0; 1x 6,0x60,0; 1x 6,0x140,0; 1x 7,0x60,0; 1x 8,0x60,0; 1x 10,0x60,0
	9822	1x 344,0x30,0x392,0

9723 泡垫 Zyklop B 3/8" 批头套筒组套 1



22 件 3/8" Zyklop 批头套筒组套装入 Tool Rebel 车间手推车的双色泡垫内。宽x高x深: 无工具 172 x 30 x 392 mm、有工具 172 x 39 x 392 mm。

05150113001		
●●	8784 B1	1x 1/4"x3/8"x44,0
●	8767 B HF	1x TX 15x35,0; 1x TX 20x35,0; 1x TX 25x35,0; 1x TX 25x107,0; 1x TX 27x35,0; 1x TX 27x107,0; 1x TX 30x35,0; 1x TX 30x107,0; 1x TX 40x35,0; 1x TX 40x107,0
○	8740 B HF	1x 4,0x35,0; 1x 4,0x107,0; 1x 5,0x35,0; 1x 5,0x107,0; 1x 6,0x35,0; 1x 6,0x107,0; 1x 7,0x38,5; 1x 8,0x38,5; 1x 8,0x100,0; 1x 10,0x38,5; 1x 10,0x100,0
	9823	1x 172,0x30,0x392,0

安全储存和快速概述

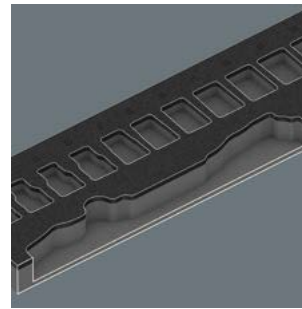

由于精确的等高线切断, 这些工具牢固收放于泡垫中, 但很容易拆除。精心设计的工具布置确保了节省空间的储存和快速进入每种工具。

9730 泡垫 6000 Joker 组套 1



11 件 6000 件 Joker 环形棘轮扳手组套装入 Tool Rebel 车间手推车的双色泡垫内。宽x高x深: 无工具 172 x 30 x 392 mm、有工具 172 x 47 x 392 mm。

05150120001		
	6000 Joker	1x 8x144; 1x 10x159; 1x 11x165; 1x 12x170,7; 1x 13x177; 1x 14x188; 1x 15x200; 1x 16x212; 1x 17x224; 1x 18x235; 1x 19x246
	9830	1x 172,0x30,0x392,0

9731 泡垫 6003 Joker 组套 1



18 件 6003 Joker 环形扳手组套和 1 个 Kraftform 开瓶器装入 Tool Rebel 车间手推车的双色泡垫内。宽x高x深: 无工具 344 x 30 x 392 mm、有工具 344 x 58 x 392 mm。

05150121001		
	6003 Joker	1x 6x105; 1x 7x110; 1x 8x115; 1x 9x120; 1x 10x125; 1x 11x135; 1x 12x148; 1x 13x160; 1x 14x167; 1x 15x174; 1x 16x182; 1x 17x190; 1x 18x210; 1x 19x230; 1x 20x230; 1x 21x260; 1x 22x260; 1x 24x280
	开瓶器	1x 145
	9831	1x 344,0x30,0x392,0

9732 泡垫 6004 Joker 组套 1



5 件 6004 Joker 自调式扳手组套装入 Tool Rebel 车间手推车的双色泡垫内。宽x高x深：无工具 172 x 30 x 392 mm、有工具 172 x 35 x 392 mm。

05150122001	
	6004 Joker XS 1x 7-10 (1/4"-3/8")x117
	6004 Joker S 1x 10-13 (7/16"-1/2")x154
	6004 Joker M 1x 13-16 (1/2"-5/8")x188
	6004 Joker L 1x 16-19 (5/8"-3/4")x224
	6004 Joker XL 1x 19-24 (3/4"-15/16")x256
	9832 1x 172,0x30,0x392,0

9740 泡垫 L 型扳手组套 1



18 件 L 型扳手组套 (内六角螺丝和 TORX® 梅花螺丝) 加上一个 Wera 加磁器和一个 Stabila 袖珍卷尺 (3米) 装入 Tool Rebel 车间手推车的双色泡垫内。宽x高x深：无工具 172 x 30 x 392 mm、有工具 172 x 44 x 392 mm。

05150140001	
	1x 950/9 Hex-Plus Multicolour 1
○	950 SPKL Multicolour 1x 1.5x90; 1x 2.0x101; 1x 2.5x112; 1x 3.0x123; 1x 4.0x137; 1x 5.0x154; 1x 6.0x172; 1x 8.0x195; 1x 10.0x224
	1x 967/9 TX XL Multicolour 1
⊕	967 SXL TORX® Multicolour 1x TX 8x90; 1x TX 9x101; 1x TX 10x112
⊕	967 SPKXL TORX® Multicolour 1x TX 15x123; 1x TX 20x137; 1x TX 25x154; 1x TX 27x172; 1x TX 30x195; 1x TX 40x224
	1x 9500 1x 48.0
	1x STABILA® 袖珍卷尺 BM 100, 3 m, 项目 19570 1x 3000,0
	1x 9840 1x 172,0x30,0x392,0

双色泡垫



拆下工具后，浅灰色的第二层泡垫就会显现出来，因此很快就能识别出缺失的工具。

9750 泡垫 Kraftform Kompakt 和 Tool-Check PLUS 组套 1



57 件工具组套 (1 件 Tool-Check PLUS (39 件)、1 件 Kraftform Kompakt 60 (16 件) 和 1 件带软轴的插换式螺丝刀) 装入 Tool Rebel 车间手推车的双色泡垫内。宽x高x深：无工具 172 x 30 x 392 mm、有工具 172 x 59 x 392 mm。

05150150001	
	1x Tool-Check PLUS 组套
○	8001 A 1x 1/4"x87.0
●	813 1x 1/4"x78
⊕	889/4/1 K 1x 1/4"x50
⊕	870/1 1x 1/4"x25 1)
●	8790 HMA 1x 5.5x23.0; 1x 6.0x23.0; 1x 7.0x23.0; 1x 8.0x23.0; 1x 10.0x23.0; 1x 12.0x23.0; 1x 13.0x23.0
⊕	851/1 TZ 2x PH 1x25; 3x PH 2x25; 1x PH 3x25
⊕	855/1 TH 1x PZ 1x25; 3x PZ 2x25; 1x PZ 3x25
⊕	867/1 TZ TORX® 1x TX 10x25; 1x TX 15x25; 1x TX 20x25; 1x TX 25x25; 1x TX 30x25; 1x TX 40x25
⊕	867/1 Z TORX® BO 1x TX 10x25; 1x TX 15x25; 1x TX 20x25; 1x TX 25x25; 1x TX 30x25
○	840/1 Z 1x 3.0x25; 1x 4.0x25; 1x 5.0x25; 1x 6.0x25; 1x 8.0x25
⊕	800/1 TZ 1x 1.0x5.5x25
	1x Kraftform Kompakt 60
●	816 R 1x 1/4"x119
⊕	851/4 Z 1x PH 1x89; 1x PH 2x89; 1x PH 3x89
⊕	855/4 Z 1x PZ 1x89; 1x PZ 2x89; 1x PZ 3x89
⊕	867/4 Z TORX® BO 1x TX 10x89; 1x TX 15x89; 1x TX 20x89; 1x TX 25x89; 1x TX 30x89
⊕	800/4 Z 1x 1.0x5.5x89
○	840/4 Z 1x 3.0x89; 1x 4.0x89; 1x 5.0x89; 1x 6.0x89
	魔术贴 70 1x 50.0x70.0
	1x 393 S 插换式软轴螺丝刀
●	1x 1/4"x173,5
	1x 9850 1x 172,0x30,0x392,0

注意：泡垫不适用于旧型号 05501051001 的车间手推车。

9780 泡垫 KNIPEX 钳组套 1



3件钳组套(1件 KNIPEX 组合钳, 镀铬, 1件 KNIPEX Cobra® 高科技水泵钳, 镀铬, 1件 KNIPEX 高杠杆斜切刀, 镀铬)装入 Tool Rebel 车间手推车的双色泡垫内。宽x高x深: 无工具 172 x 30 x 392 mm、有工具 172 x 38 x 392 mm。

05150180001		
	KNIPEX 钢丝平嘴老虎钳 03 05 180	1x 180
	KNIPEX® Cobra® 高科技水泵钳 87 05 250	1x 250
	KNIPEX 省力斜口钳 74 05 160	1x 160
	9880	1x 172,0x30,0x392,0

9782 泡垫锤组套 1



6件工具组套(1把 PICARD® 铆钉锤(500克)、4个彩色编码的 RENNSTEIG 销子冲头、1把 RENNSTEIG 扁平冷凿)装入 Tool Rebel 车间手推车的双色泡垫内。宽x高x深: 无工具 172 x 30 x 392 mm、有工具 172 x 35 x 392 mm。

05150182001		
	PICARD® 铆钉锤500g, 0000101-500	1x 500,0
○	RENNSTEIG 限量穿孔工具	1x 452 003 6 RC, 3,0x150; 1x 452 004 6 RC, 4,0x150; 1x 452 006 6 RC, 6,0x150; 1x 452 008 6 RC, 8,0x150
●	RENNSTEIG 平头凿 310 250 1 9882	1x 25,0x13,0x23,0 1x 172,0x30,0x392,0

9781 泡垫 KNIPEX 钳组套 2

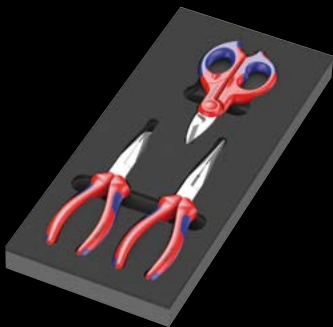

3件钳组套(1件 KNIPEX 鹬嘴侧切割钳(鹬嘴钳), 1件 KNIPEX 机工用钳, 1件 KNIPEX 电工剪切机)装入 Tool Rebel 车间手推车的双色泡垫内。宽x高x深: 无工具 172 x 30 x 392 mm、有工具 172 x 38 x 392 mm。

05150181001		
	KNIPEX 尖嘴钳26 15 200	1x 200
	KNIPEX 机工用钳 38 25 200	1x 200
	KNIPEX 不锈钢电工剪 95 05 155	1x 155
	9881	1x 172,0x30,0x392,0

9783 泡垫 PFERD 锉刀组套 1

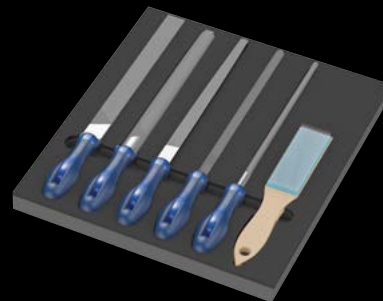

6件锉刀组套(1件 PFERD 方锉 PF1142 250 H2、1件 PFERD 半圆尖头锉 PF 1152SP 250 H2、1件 PFERD 圆锉 PF1162 250 H2、1件 PFERD 手锉 PF1112 250 H2、1件 PFERD 三角锉 PF 1132 250 H2、1件 PFERD 刮刷 HBF ST 0.15)装入 Tool Rebel 车间手推车的双色泡垫内。宽x高x深: 无工具 344 x 30 x 392 mm、有工具 344 x 42 x 392 mm。

05150183001		
	PFERD 机工用方锉 PF1142 250 H2	1x 250
	PFERD 机工用半圆尖头锉 1152SP 250 H2	1x 250
	PFERD 机工用圆锉 1162 250 H2	1x 250
	PFERD 机工用手锉 1112 250 H2	1x 250
	PFERD 机工用三角锉 1132 250 H2	1x 250
	PFERD 刮刷 HBF 钢丝直径不小于0.15	1x 232
	9883	1x 344,0x30,0x392,0